

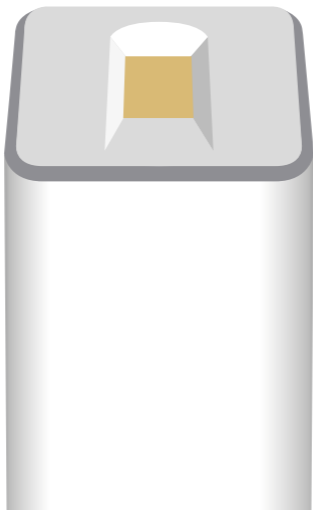

rechargeable fingerprint
scanner, wireless

Quick Start Guide



Battery-operated variant

Scope of delivery

- ekey uno
- Rechargeable battery
- Torx screwdriver
- Charger
- Bottom cap
- Safety screw
- Screws for fastening the ekey uno to the mounting plate
- Screw anchors and screws for fastening the mounting plate to the wall (screw variant)

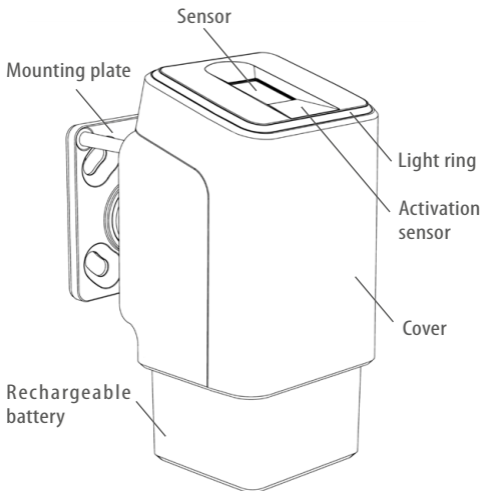

Observe the enclosed Safety information.

Battery-operated variant

- 1** Activate the eqiva BLUETOOTH® Smart Lock
Follow the operating instructions of the eqiva BLUETOOTH® Smart Lock

eqiva

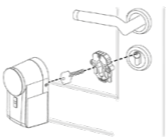

- 2** Fully charge the ekey uno battery
Charging time max. 5 hours

- Battery is charging
- Battery is fully charged



! You can only activate the system successfully with a fully charged battery.

- 3** Define the position for the ekey uno

Determine a suitable position outside for your ekey uno before you start mounting it. Right next to the door, for example.
It is **IMPORTANT** to note:



- ! The device must be easy to reach with one's hand.
- ! The installation height of **at least 110 cm** is important for ergonomically correct operation and must therefore be observed.
- ! The ekey uno communicates wirelessly with the door lock actuator. Both devices must therefore be installed in close proximity* to one another.

*According to the BLE wireless connection standard, the typical range is 10 m. However, this can be lower, depending on the installation situation and the type of door.

- 4** Attach the mounting plate - **minimum height 110 cm**



Glue variant*

An adhesive foil is already attached to the mounting plate. Remove the base foil and adhere the mounting plate.

OR

Screw variant

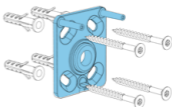

Attach the mounting plate in the previously selected mounting position. You can glue on the mounting plate or fix it with the supplied screw anchors and screws.

❗ *NOTE ON THE GLUE VARIANT:

Remove the entire base foil. Thoroughly clean the surface where the device is to be mounted. Adhere the mounting plate only to a smooth, dry surface at room temperature. Apply a **large amount of pressure** to the surface to adhere the mounting plate. The bond only reaches maximum adhesive strength after 3 days. Only then can the mounting plate be fully loaded.

❗ For further information, visit: www.ekey-uno.net/faq.

5 Remove the cover from the ekey uno

Slide up and tilt to one side

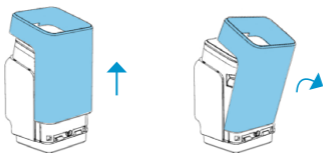

6 Fasten the ekey uno to the mounting plate using the screws provided

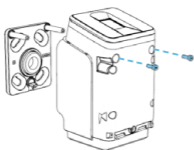

7 Open the metal clamp and remove the bottom cap

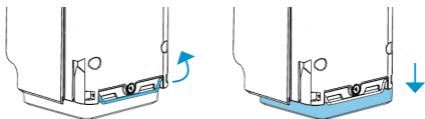

8 Insert the rechargeable battery and close the metal clamp

Make sure the battery is fully charged before inserting it.

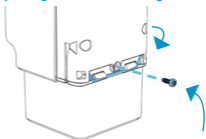
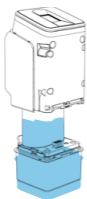

OPTIONAL:

Attach the safety screw to fix the rechargeable battery and protect it against manipulation

9 Attach cover

Apply at an angle, tilt towards the middle and slide down

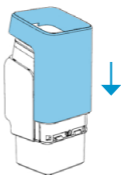
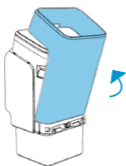

ekey uno app

10 Download the app

You need the **free** ekey uno app for mobile devices to activate your ekey uno with the eqiva BLUETOOTH® Smart Lock and for user administration.

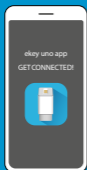

ekey uno



eqiva
BLUETOOTH®
Smart Lock

www.ekey-uno.net

You can find all the information about your ekey uno retrofitting set (functions of the app, videos on activation, etc.) on our website www.ekey-uno.net.

Apple and the Apple logo are trademarks of Apple Inc., registered in the U.S. and other countries. Google Play and the Google Play logo are trademarks of Google LLC.

Operating the ekey uno



Your device is equipped with an activation sensor to enable the long rechargeable battery life of approx. 6 months. The activation sensor is shown here with a blue symbol. When operating the ekey uno, always ensure that you touch the activation sensor. Otherwise the device remains disabled.

Important signals

Open

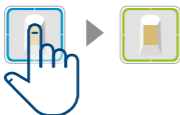

Place finger on sensor, wait until LEDs flash blue. As soon as the LEDs flash blue, remove your finger.

Close

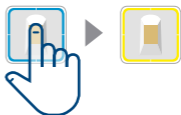

Place finger on sensor, wait until LEDs flash blue. Place finger on sensor again while LEDs are flashing.

No connection to door lock actuator



Connect ekey uno with mobile device

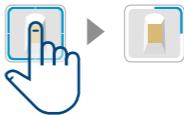

Place finger on sensor until top right segment flashes.

www.ekey-uno.net

ID329/736/0/694:
Version 2, 2020-08-13



Copyright © 2020 ekey biometric systems GmbH.
All content, artwork and ideas contained in this Quick Start Guide are subject to applicable copyright laws. Any transmission, relinquishment or transfer of this content or parts thereof to third parties requires the prior written consent of ekey biometric systems GmbH. Translation of the original documentation.

ekey
uno

fingerprint scanner,
wireless

Quick Start Guide

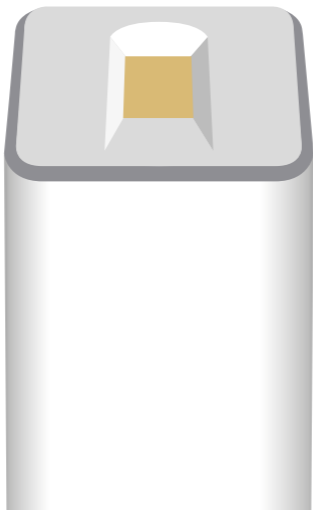

Mains-powered variant

Scope of delivery

- ekey uno
- Torx screwdriver
- Wall power supply for permanent supply of power
- Bottom cap
- Safety screw
- Screws for fastening the ekey uno to the mounting plate
- Screw anchors and screws for fastening the mounting plate to the wall (screw variant)

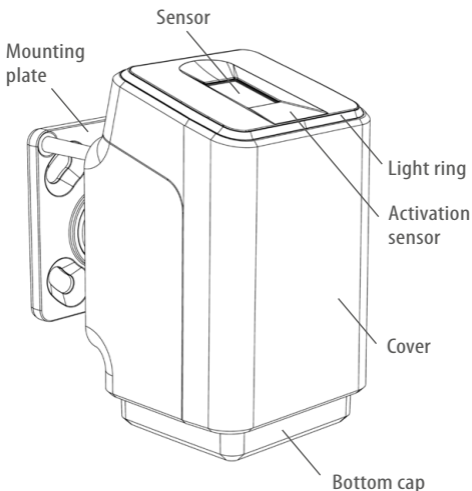

Observe the enclosed Safety information.

Mains-powered variant

- 1 Activate the eqiva BLUETOOTH® Smart Lock
Follow the operating instructions of the eqiva BLUETOOTH® Smart Lock

eqiva

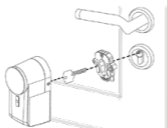

- 2 Define the position for the ekey uno

Determine a suitable position outside for your ekey uno before you start mounting it. Right next to the door, for example.

It is **IMPORTANT** to note:



- ❗ The device must be easy to reach with one's hand.
- ❗ The installation height of **at least 110 cm** is important for ergonomically correct operation and must therefore be observed.
- ❗ The ekey uno communicates wirelessly with the door lock actuator. Both devices must therefore be installed in close proximity* to one another.

*According to the BLE wireless connection standard, the typical range is 10 m. However, this can be lower, depending on the installation situation and the type of door.

- 3 Pull cable through mounting plate

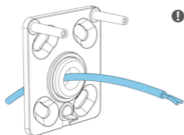

- ❗ The fingerprint scanner can be powered via the wall power supply unit (220 VAC) provided or via the power line of your door station (12 VDC-24 VDC).

- 4 Attach the mounting plate - **minimum height 110 cm**

Glue variant*

OR

Screw variant



An adhesive foil is already attached to the mounting plate. Remove the base foil and adhere the mounting plate.

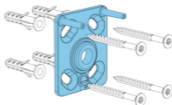

Attach the mounting plate in the previously selected mounting position. You can glue on the mounting plate or fix it with the supplied screw anchors and screws.

❗ ***NOTE ON THE GLUE VARIANT:**

Remove the entire base foil. Thoroughly clean the surface where the device is to be mounted. Adhere the mounting plate only to a smooth, dry surface at room temperature. Apply a **large amount of pressure** to the surface to adhere the mounting plate. The bond only reaches maximum adhesive strength after 3 days. Only then can the mounting plate be fully loaded.

❗ For further information, visit:

<https://ekey-biometric-systems.helpshift.com/a/ekeyuno/?l=en>.

5 Remove the cover from the ekey uno

Slide up and tilt to one side

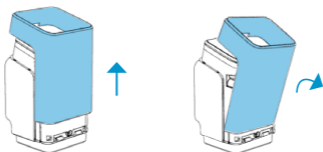

6 Open the metal clamp and remove the bottom cap

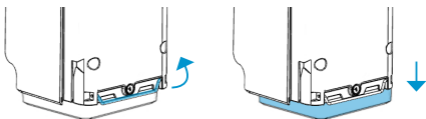

7 Thread cable through and connect*

Then fasten the ekey uno to the mounting plate using the screws provided

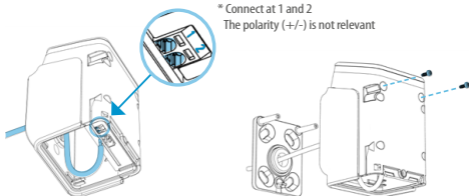

* Connect at 1 and 2

The polarity (+/-) is not relevant

8 Insert the cap and close the metal clamp

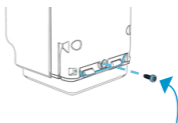
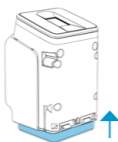

OPTIONAL:
Attach the safety screw to fix the cap
and protect it against manipulation

9 Attach cover

Apply at an angle, tilt towards the middle and slide down

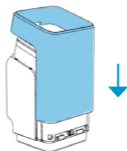
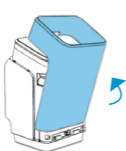

ekey uno app

10 Download the app

You need the **free** ekey uno app for mobile devices to activate your ekey uno with the eqiva BLUETOOTH® Smart Lock and for user administration.



ekey uno



eqiva
BLUETOOTH®
Smart Lock

www.ekey-uno.net

You can find all the information about your ekey uno retrofitting set (functions of the app, videos on activation, etc.) on our website www.ekey-uno.net.

Apple and the Apple logo are trademarks of Apple Inc., registered in the U.S. and other countries. Google Play and the Google Play logo are trademarks of Google LLC.

www.ekey-uno.net | This document is not subject to updating. We reserve the right to make technical modifications and change the product's appearance; any liability for errors and misprints is excluded.

Operating the ekey uno



Your device is equipped with an activation sensor to enable the long rechargeable battery life of approx. 6 months. The activation sensor is shown here with a blue symbol. When operating the ekey uno, always ensure that you touch the activation sensor. Otherwise the device remains disabled.

Important signals

Open

Place finger on sensor, wait until LEDs flash blue. As soon as the LEDs flash blue, remove your finger.

Close

Place finger on sensor, wait until LEDs flash blue. Place finger on sensor again while LEDs are flashing.

No connection to door lock actuator

Connect ekey uno with mobile device

Place finger on sensor until top right segment flashes.

www.ekey-uno.net

ID336/737/0/698:
Version 2, 2020-08-13



Copyright © 2020 ekey biometric systems GmbH.
All content, artwork and ideas contained in this Quick Start Guide are subject to applicable copyright laws. Any transmission, relinquishment or transfer of this content or parts thereof to third parties requires the prior written consent of ekey biometric systems GmbH. Translation of the original documentation.